

Zero Waste

Collection Printemps Été 2018

Spring Summer 2018 Collection

Cette collection a été conçue pour ne créer aucun gaspillage.

This collection has been designed to create no waste.

Demandez aux filles votre patron ou téléchargez-le sur www.skunkfunk.com

Ask the girls for your pattern or download it at www.skunkfunk.com

Téléchargez vos créations et taggez-nous! [@skunkfunk_official](https://www.instagram.com/skunkfunk_official).

Share your creation and tag us! [@skunkfunk_official](https://www.instagram.com/skunkfunk_official).

Dhalia

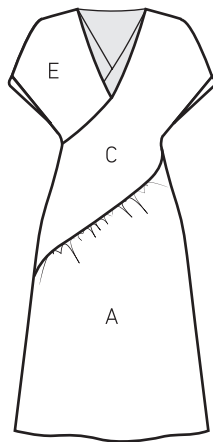

LE DOS / FRONT

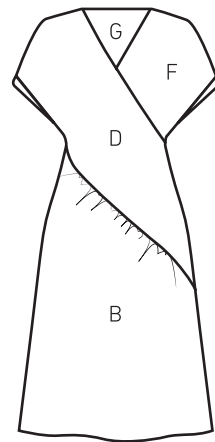

L'AVANT / BACK

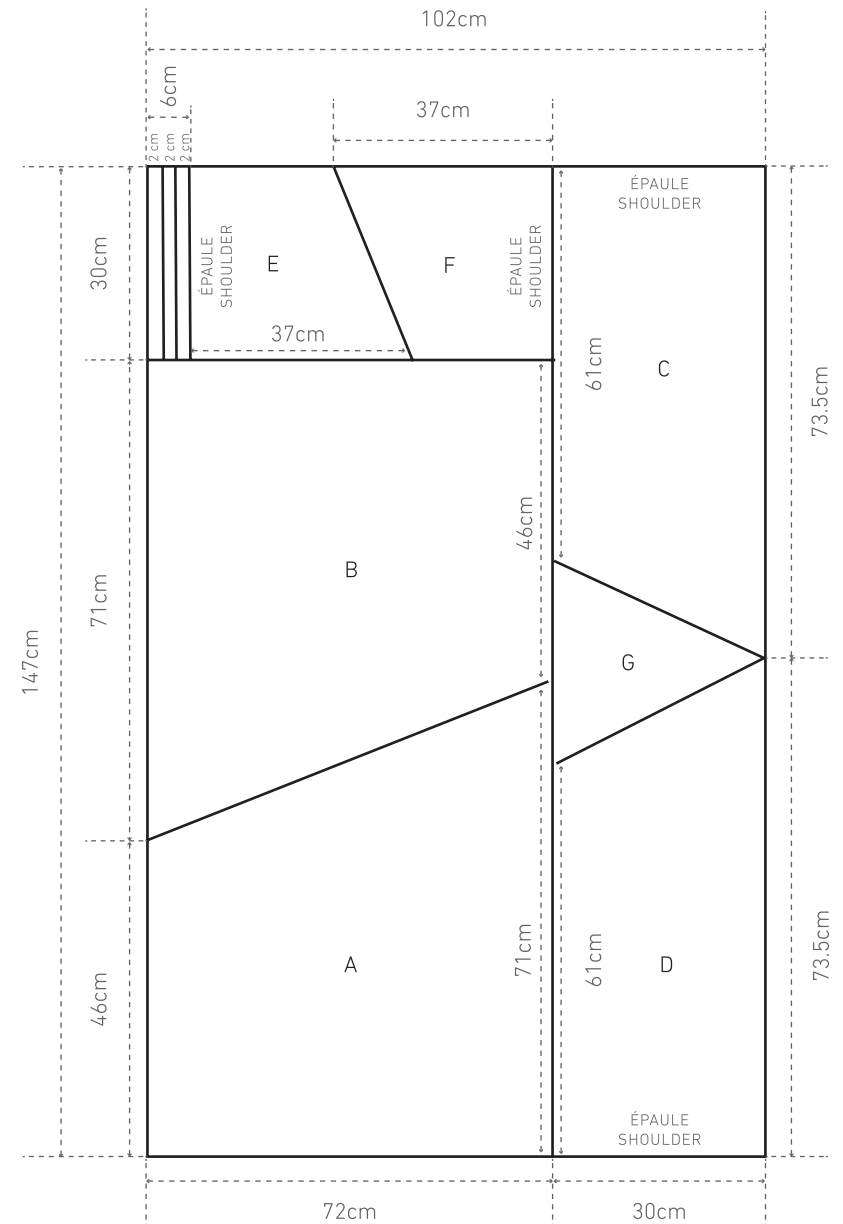

Arum

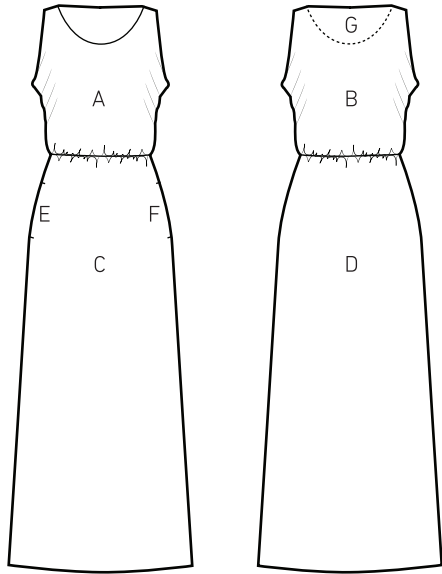

LE DOS / FRONT

L'AVANT / BACK

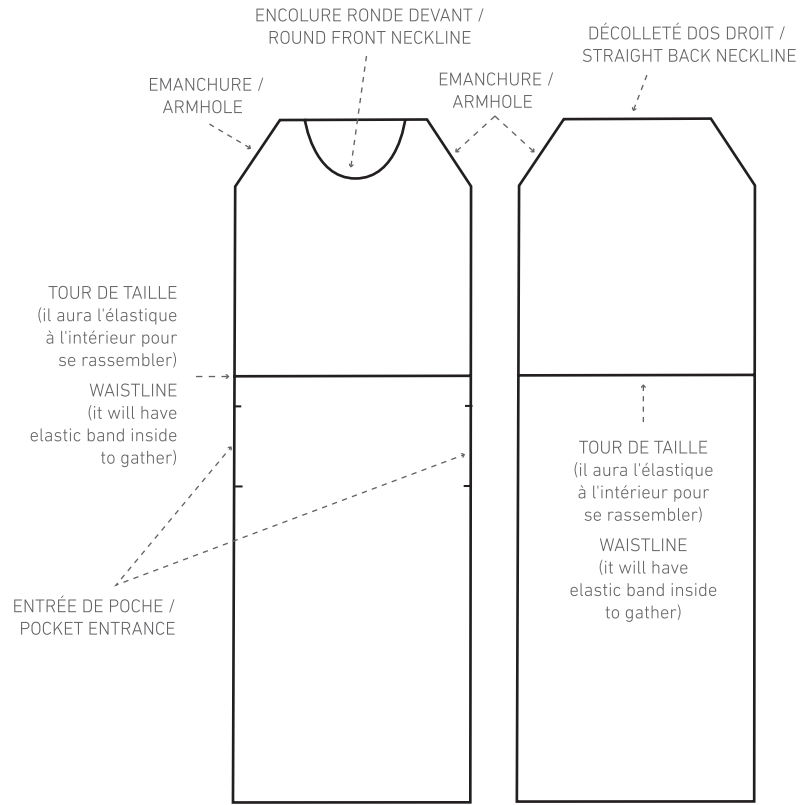

LE DOS / FRONT

L'AVANT / BACK

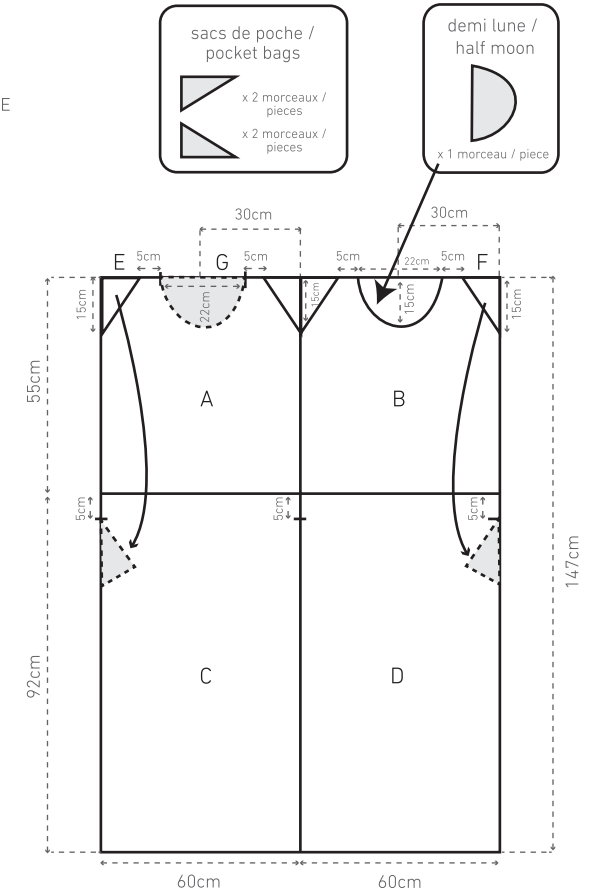

Zero Waste

Collection Printemps Été 2018

Spring Summer 2018 Collection

Cette collection a été conçue pour ne créer aucun gaspillage.

This collection has been designed to create no waste.

Demandez aux filles votre patron ou téléchargez-le sur www.skunkfunk.com

Ask the girls for your pattern or download it at www.skunkfunk.com

Téléchargez vos créations et taggez-nous! [@skunkfunk_official](https://twitter.com/skunkfunk_official).

Share your creation and tag us! [@skunkfunk_official](https://twitter.com/skunkfunk_official).

Kerria

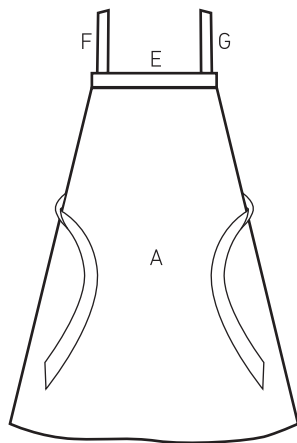

LE DOS / FRONT

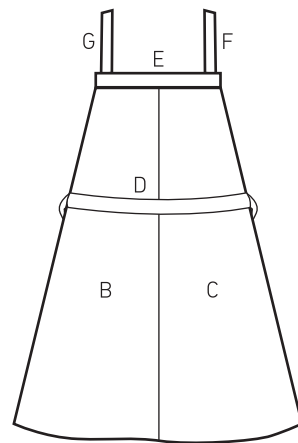

L'AVANT / BACK

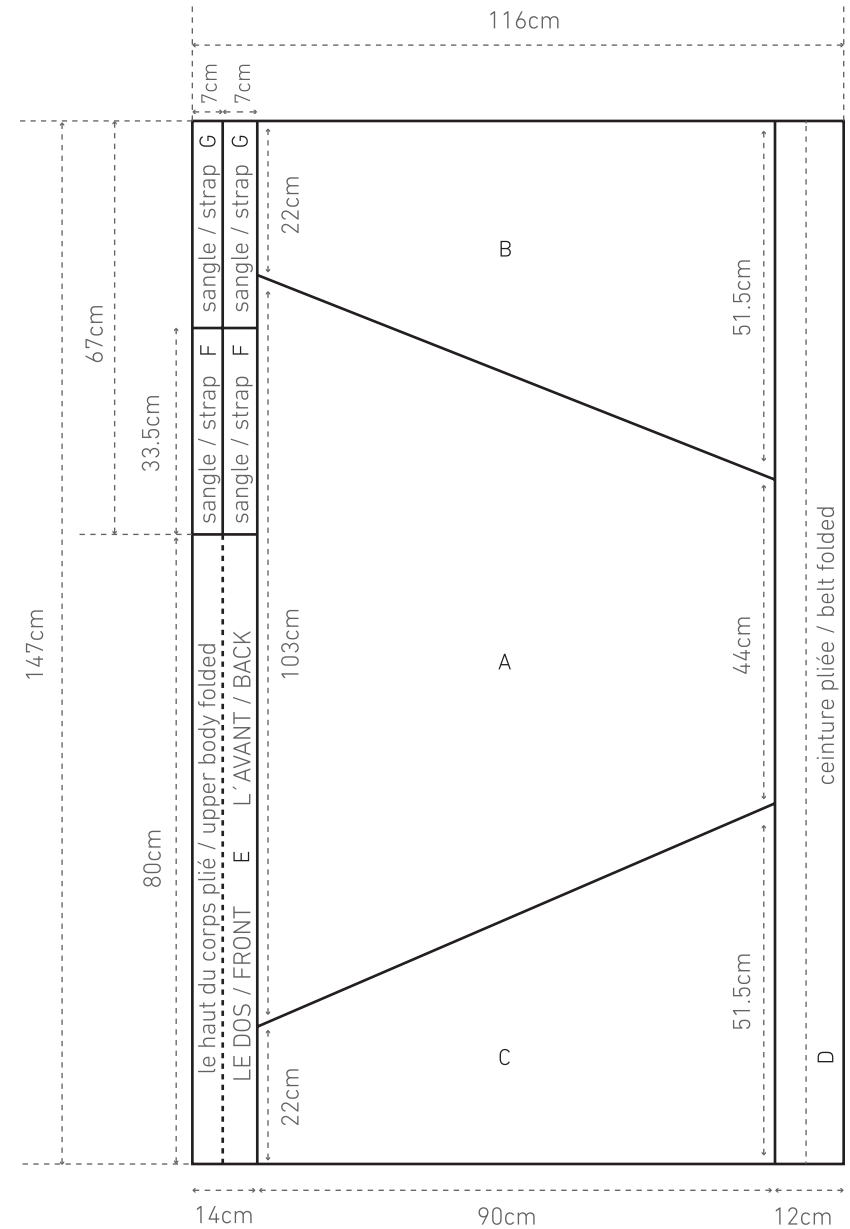

Mezkia

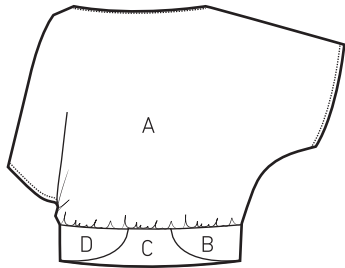

LE DOS / FRONT

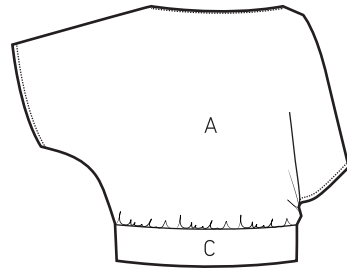

L'AVANT / BACK

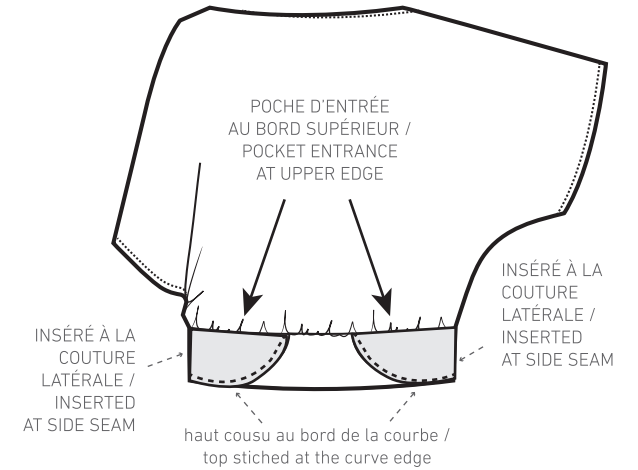
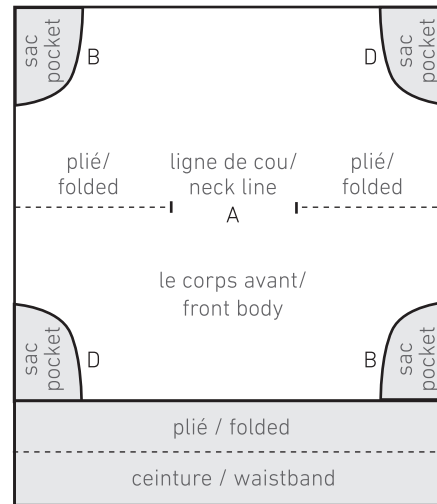
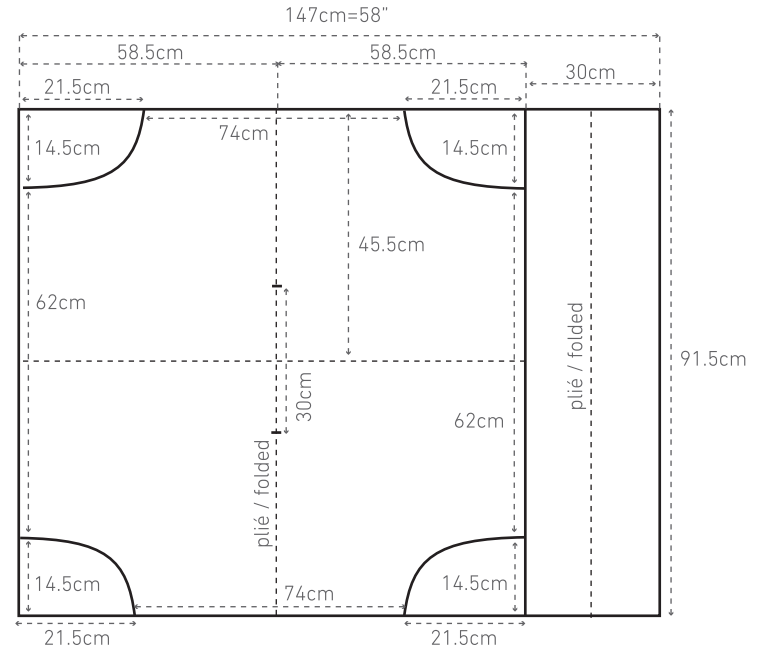

POCHES À DOUBLE ÉPAISSEUR / DOUBLE LAYERED POCKETS